

BSK Fertigkanalsystem I 30 bis I 120 gem. DIN 4102-11

Brandschutzkanal aus Stahlblech mit innenseitiger intumeszierender Beschichtung

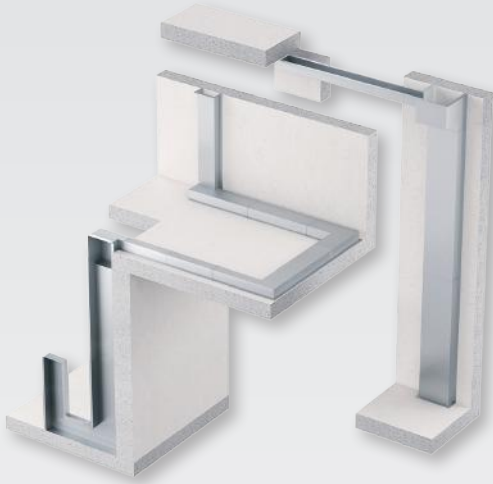

Systemdaten

Verwendbarkeitsnachweis		Z.19.30-2232
Maximale Kanalgröße	Vierseitige Ausführung	1000 x 500
	Dreiseitige Ausführung	500 x 260
	Zweiseitige Ausführung	500 x 260

Alle Angaben in mm

Allgemeine Informationen

Einsatzbereiche

- Befestigung an Wänden und Decken
- Durchführung durch Leichte Trennwand und Massivwand

Produkte

	Gerader Kanal, 2000 mm, I 90		
	Maße [mm]	Art.-Nr.	
		weiß	verzinkt
	2000 x 30 x 30	42111	41111
	2000 x 40 x 40	42121	41121
	2000 x 80 x 50	42131	41131
	2000 x 200 x 50	42141	41141
	2000 x 260 x 100	42151	41151
2000 x 400 x 120	42161	41161	
	Gerader Kanal, 1000 mm, I 90		
	Maße [mm]	Art.-Nr.	
		weiß	verzinkt
	1000 x 80 x 50	42132	41132
	1000 x 200 x 50	42142	41142
	1000 x 260 x 100	42152	41152
1000 x 400 x 120	42162	41162	
	Montagewinkel, I 90		
	Maße [mm]	Art.-Nr.	
		weiß	verzinkt
1000 x 50 x 30	46530	43530	
	Trennsteg, I 90		
	Maße [mm]	Art.-Nr.	
		weiß	verzinkt
	2000 x 46	-	43246
	2000 x 96	-	43296
2000 x 116	-	43116	
	Flachwinkel 90°, I 90		
	Maße [mm]	Art.-Nr.	
		weiß	verzinkt
	100 x 80 x 50	42133	41133
	100 x 200 x 50	42143	41143
100 x 260 x 100	42153	41153	
100 x 400 x 120	42163	41163	

BSK Fertigkanalsystem I 30 bis I 120 gem. DIN 4102-11

	Innenecke 90°, I 90		
	Maße [mm]	Art.-Nr.	
		weiß	verzinkt
	50 x 30 x 30	42114	41114
	50 x 40 x 40	42124	41124
	50 x 80 x 50	42134	41134
	50 x 200 x 50	42144	41144
	50 x 260 x 100	42154	41154
	50 x 400 x 120	42164	41164

	Außenecke 90°, I 90		
	Maße [mm]	Art.-Nr.	
		weiß	verzinkt
	50 x 30 x 30	42115	41115
	50 x 40 x 40	42125	41125
	50 x 80 x 50	42135	41135
	50 x 200 x 50	42145	41145
	50 x 260 x 100	42155	41155
	50 x 400 x 120	42165	41165

	T-Stück, I 90		
	Maße [mm]	Art.-Nr.	
		weiß	verzinkt
	50 x 30 x 30	42116	41116
	50 x 40 x 40	42126	41126
	50 x 80 x 50	42136	41136
	50 x 200 x 50	42146	41146
	50 x 260 x 100	42156	41156
	50 x 400 x 120	42166	41166

	Abschlusskappe, I 90		
	Maße [mm]	Art.-Nr.	
		weiß	verzinkt
	30 x 30	42117	41117
	40 x 40	42127	41127
	80 x 50	42137	41137
	200 x 50	42147	41147
	260 x 100	42157	41157
	400 x 120	42167	41167

	Wandanschlusskragen, I 90		
	Maße [mm]	Art.-Nr.	
		weiß	verzinkt
	30 x 30	42118	41119
	40 x 40	42128	41129
	80 x 50	42138	41139
	200 x 50	42148	41149
	260 x 100	42158	41159
	400 x 120	42168	41169

	Kabelauführung, Mineralfaserschott, I 90		
	Maße [mm]	Art.-Nr.	
		weiß	verzinkt
	50 x 50	47555	44155
	100 x 50	47155	44555

	Kabelauführung, Brandschutzstein, I 90		
	Maße [mm]	Art.-Nr.	
		weiß	verzinkt
	50 x 50	48555	45555
	100 x 50	48155	45155

Sonderabmessungen und andere RAL-Farbtöne auf Anfrage